

total square footage: 440 sqft

top view

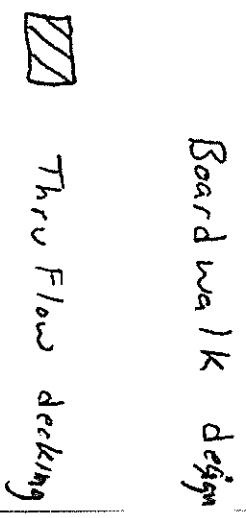
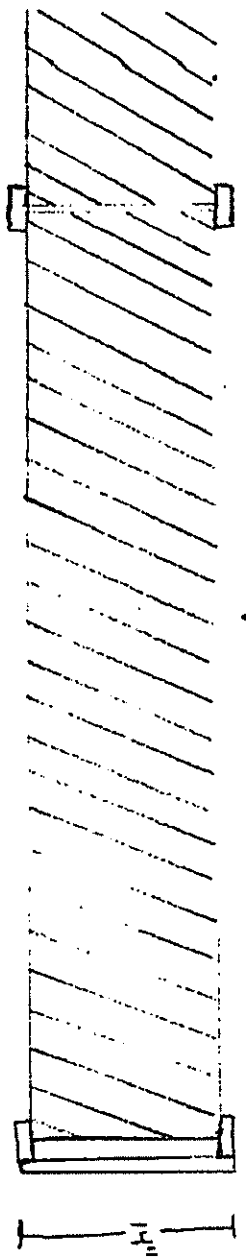
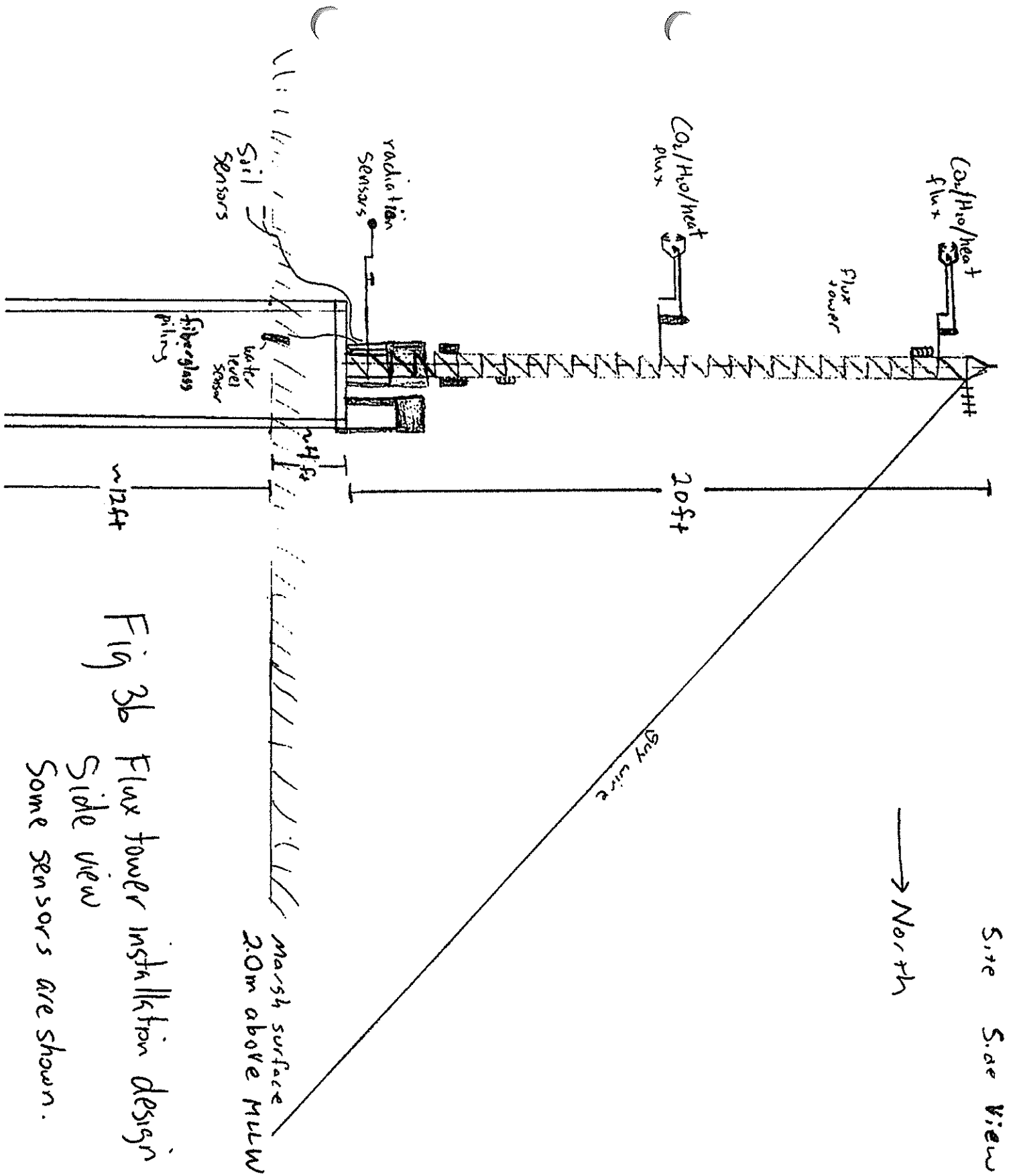

Fig 3f. Boardwalk design



Site Side View

→ North

Fig 3b Flux tower installation design
Side view

Some sensors are shown.

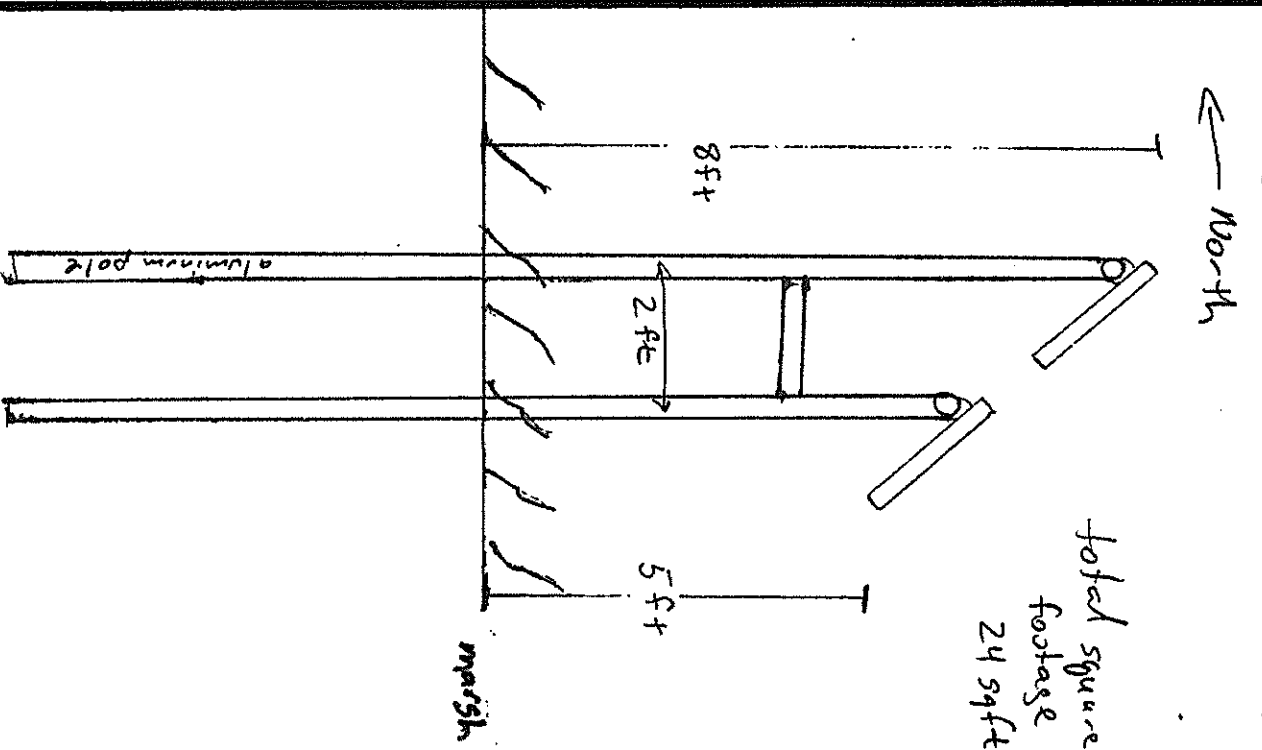
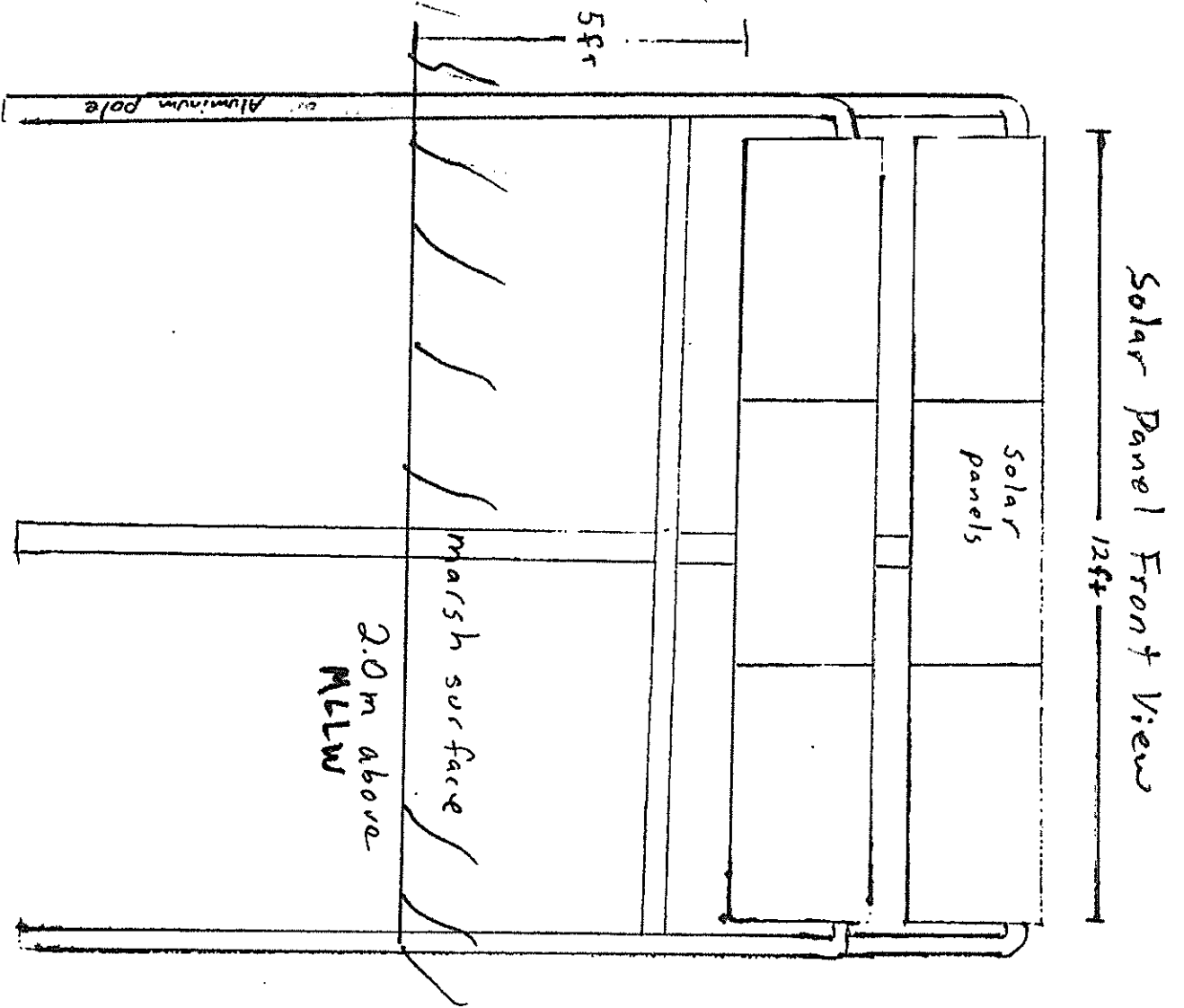

Fig 3e. Solar Panel mounting frame-
Front and side views

Site Overhead View

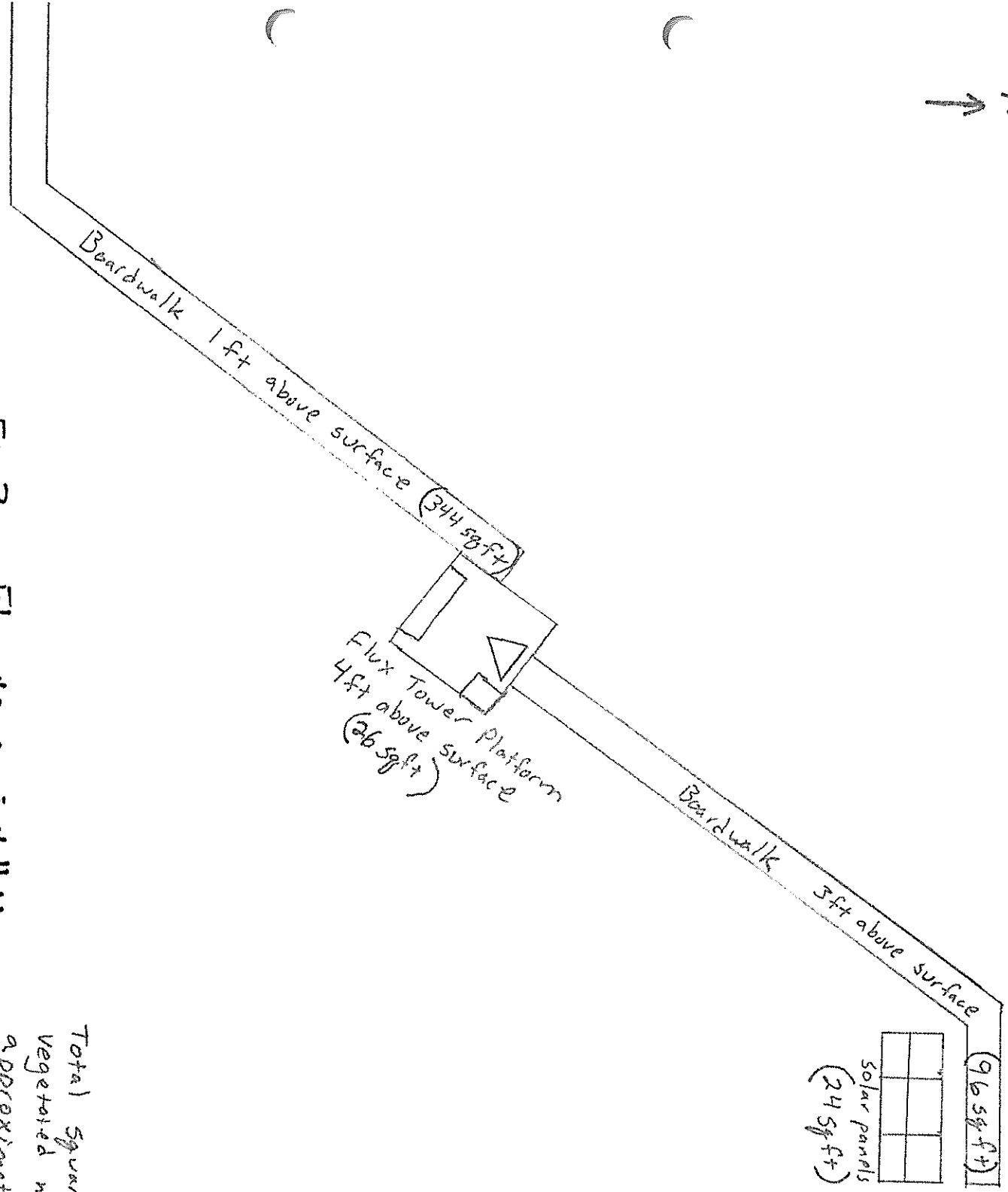

Fig 3a. Flux tower installation Overhead View

Total square footage over vegetated marsh is approximately 490 sq ft



Fig 1. Flux tower site relative to Sapelo Island, the Duplin River, and Doboy Sound.

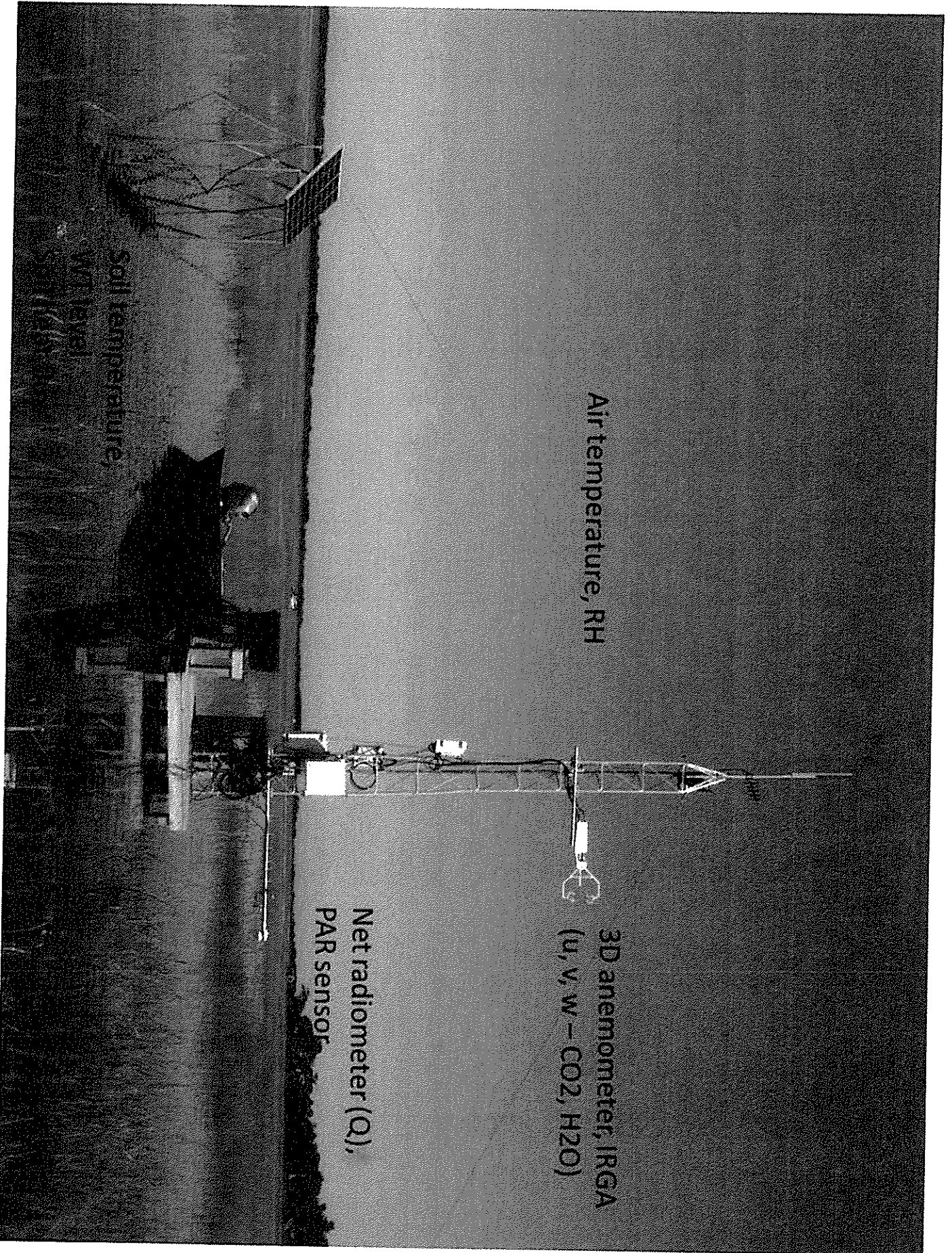

Fig 4. Flux tower installation at Plum Island Ecosystems LTER